

PT-SERIES

The Edhard PT-Series is a stand-alone system that can be used as a dosing pump and also as a transfer pump. Its reversible motor means that this system can be used with a suction tube (for looser products) as well as a gravity-fed hopper (just like our table-top units).

The system is comprised of four major components -

- 1 *Power Base*
- 2 *Pump*
- 3 *Cart*
- 4 *Suction Tube/Hopper*

Various Accessories are available to finish off the system - Batter Spouts, Elbows, Extensions, etc. Remember, if you don't see what you had in mind chances are good that we can manufacture something to meet your specifications.

Please call or e-mail with any questions.

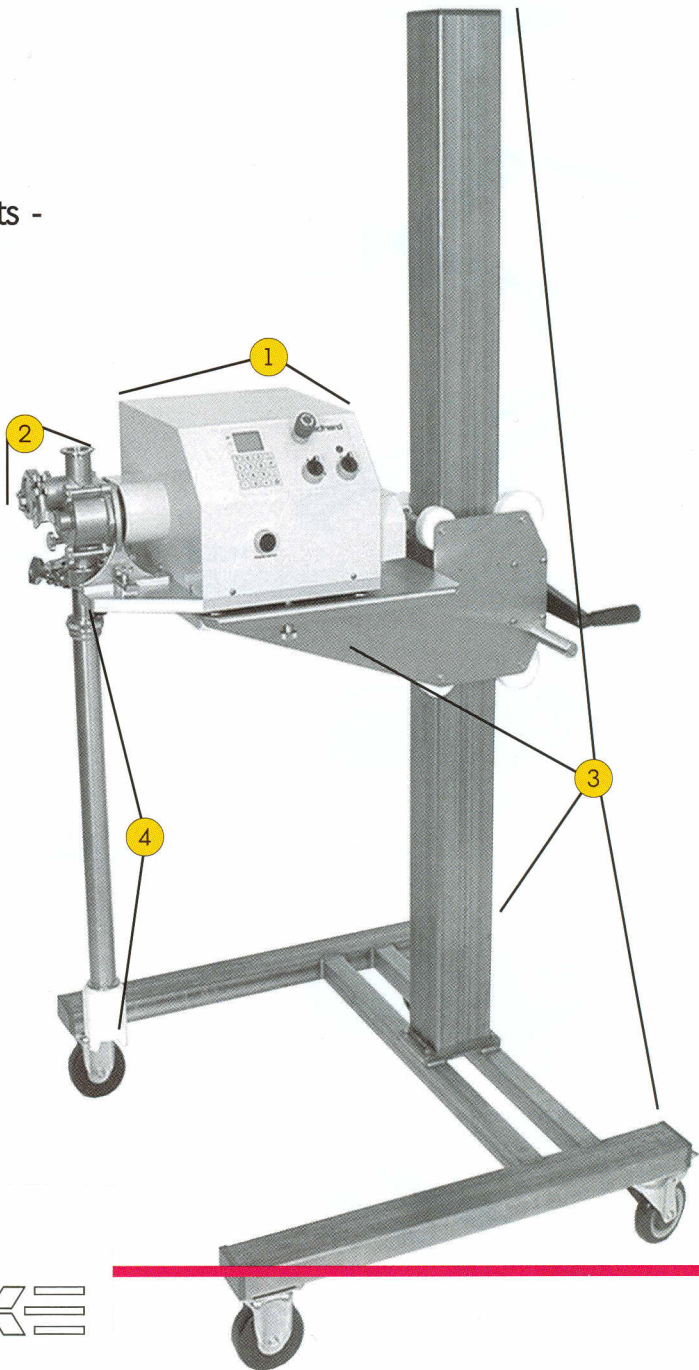

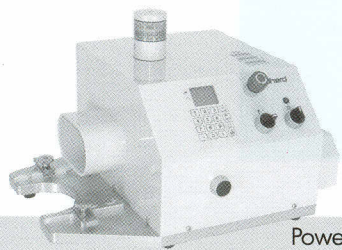

PT-4035:	200W motor	120VAC	Model MKT
PT-4036:	200W motor	220VAC	Model MKT
PT-4037:	400W motor	220VAC	Model MKT

Power Base · Variable Speed · Transfer Type

What fits me?

P

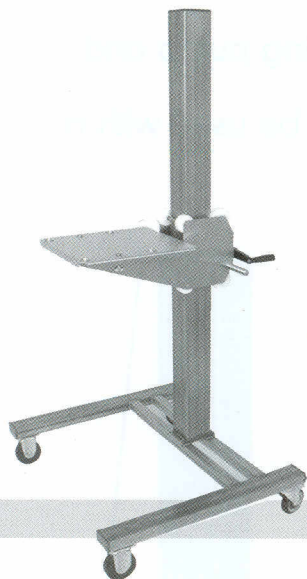

Cart

PT-8010: Stainless Steel · for use with PT-Series Power Bases

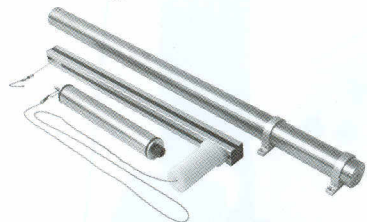

Balancer Assembly

PT-3381: Used to counterbalance a Hose Assembly- attaches to column of PT-8010

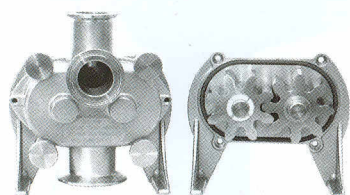

P

Pump · Suction · Stainless Steel

FT-3342: Gear-Type Stainless and Nylon Impellers
 FT-3465: Gear-Type PEEK Impellers

What fits me?

A S

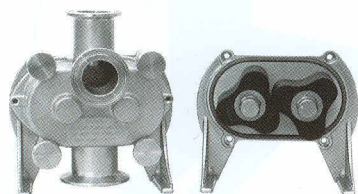

P

Pump · Suction · Stainless Steel

FTR-3343: Lobe-Type Viton 3-Lobe Impellers

What fits me?

A S



S

Suction Tube

FT-3375: 1-1/4" Ø w/ ball check valve
 FT-3430: 2" Ø w/out ball check valve



A

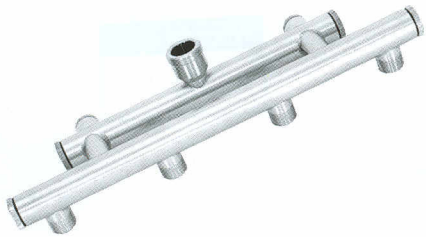

B



C

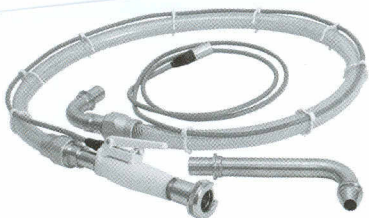

D